



BELLOW TYPE

4 1/2" x 1

PRODUCT LINE
Dunlop design line

COVER TYPE
Aluminium

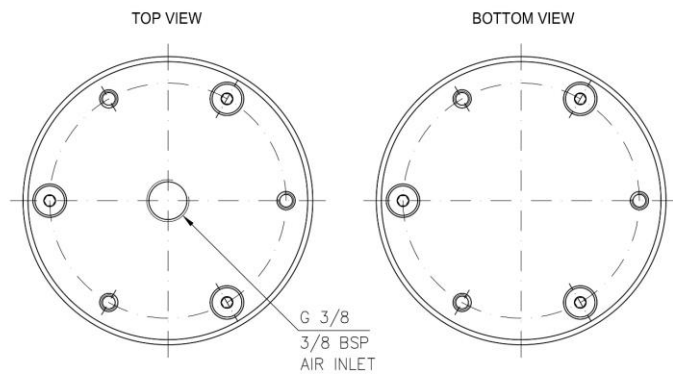
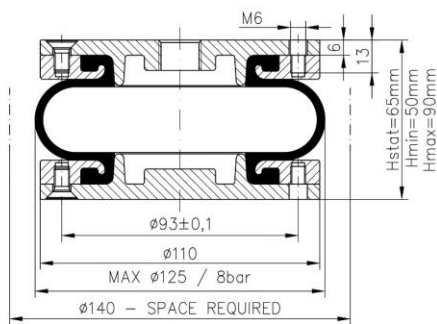

HEIGHT			STROKE	DIAMETERS	
Hmax [mm]	Hstat [mm]	Hmin [mm]	L [mm]	∅ Max [mm]	∅ For assembly [mm]
90	65	50	40	125	140

The data presented on this document are liable to change and do not constitute a commitment from Rubena, s.r.o.

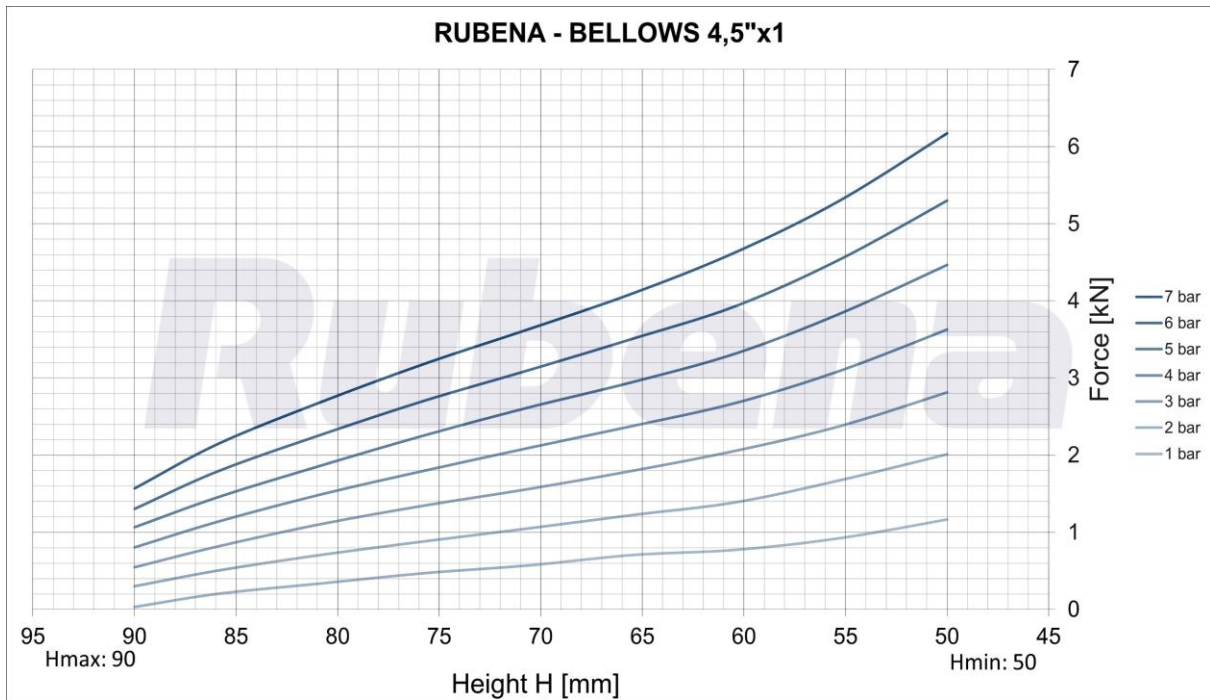

Rubber Type	Features	Application temperatures	
		Static [°C]	Dynamic [°C]
SBR	Standard use	-50° to 70°	-40° to 60°
CIIR	For higher temperature, steam and acids* resistance	-30° to 90°	-20° to 80°
ECO/GECO	Extreme heat endurance, best acids, oil and fuel resistance	-30° to 115°	-20° to 105°
CR	For higher temperature applications, acids and oil* resistance	-35° to 90°	-25° to 80°
CR (AF - Anti Fire)	For higher temperature applications, acids and oil* resistance; flame retardant, compatible with EN 45545	-50° to 90°	-40° to 80°

*depends on the type of acid / oil and their concentration. Always consult Rubena for specific use and application of the rubber type.

- 1) Airsprings must not be pressurised unless they are restricted by an outside frame or by a suitable load.
- 2) Strokes must be limited by the direct use of bump stops or external stops. When stacking airsprings, special cares must be taken to ensure the airsprings are guided and fixed
- 3) An Airspring is a single acting air actuator and must not be used below atmospheric pressure.
- 4) Please check the overpressure in case of quick compression.

The data presented on this document are liable to change and do not constitute a commitment from Rubena, s.r.o.